

320D2/D2 L

Hydraulic Excavator



Engine

Engine Model	Cat® C7.1	
Engine Power (ISO 14396)	112 kW	150 hp
Net Power (SAE J1349)	109 kW	146 hp

Weights

Maximum Operating Weight	22 300 kg	49,200 lb
Minimum Operating Weight	21 100 kg	46,500 lb

320D2/D2 L Differentiating Features

Engine and Hydraulics

A powerful Cat C7.1 engine meets U.S. EPA Tier 3, EU Stage IIIA equivalent emission standards combined with mechanical governed fuel system which is well suited for local fuels in your regions. The 320D2/D2 L maintains the same extraordinary performance.

Structures

Caterpillar design and manufacturing techniques assure you get outstanding durability and service life in the toughest applications.

Operator Station

The spacious cab features excellent visibility and easy-to-access switches. The monitor features a full-color graphical display that is user intuitive and highly visual. Overall, the new cab provides you with a comfortable working environment for maximum production and efficiency.

Reduced Service and Maintenance Cost

Routine service and maintenance can be completed quickly and easily to help you reduce ownership costs. Convenient access points, extended service intervals, and advanced filtration help keep downtime to a minimum.

Complete Customer Support

Your Cat dealer offers a wide range of services that can be set up under a customer support agreement when you purchase your equipment.

Cat 320D2/D2 L Total Solutions

Caterpillar and its extensive dealer network offer a wide variety of solutions designed to meet the unique needs of your business.

Contents

Operator Station.....	4
Engine	6
Hydraulics	7
Undercarriage and Structures	8
Front Linkage	9
Cat Connect Technology.....	10
Service and Maintenance	11
Work Tools.....	12
Complete Customer Support.....	14
Safety	15
Specifications.....	16
Standard Equipment.....	34
Optional Equipment.....	35





The 320D2/D2 L carries long time proven features and is configured for heavy construction, to improve your job site efficiency through low owning and operating costs, excellent performance, and high versatility. It will deliver great fuel savings and productivity in truck loading, trenching and lifting.

Operator Station

Enhance your comfort, operation, and visibility.
The 320D2/D2 L allows you to focus on your job.



Operator Station

The ergonomically designed operator station is spacious, quiet, and comfortable, assuring high productivity during a long work day. All switches are located in front of the operator for convenient access.

Monitor

The monitor is a full-color Liquid Crystal Display (LCD) that has the capability of displaying information in 42 languages.

Joystick Control

Low-effort pilot-operated joystick controls are designed to match your natural wrist and arm position for maximum comfort and minimum fatigue.

Seat

The suspension seat provides a variety of adjustments to accommodate a wide range of operators. All seats include a reclining back, upper and lower seat slide adjustments, and height and tilt adjustments, to meet operator needs for comfort and productivity.

Console

The right and left joystick console can be adjusted to meet individual preferences, improving operator comfort and productivity during the course of a day.

Climate Control

Positive filtered ventilation with a pressurized cab is standard. Fresh air or re-circulated air can be selected with a switch on the left console.

Cab Structure and Mounts

The cab shell features a thick steel tubing. This improves resistance to fatigue and vibration. The cab is attached to the frame with viscous rubber cab mounts, which dampen vibrations and sound levels while enhancing operator comfort.

Windows

To maximize visibility, all glass is affixed directly to the cab, eliminating window frames. The upper front windshield opens, closes, and stores on the roof above the operator with a one-touch action release system.

Wipers

Pillar-mounted wipers increase your operator's viewing area and offer continuous and intermittent modes.

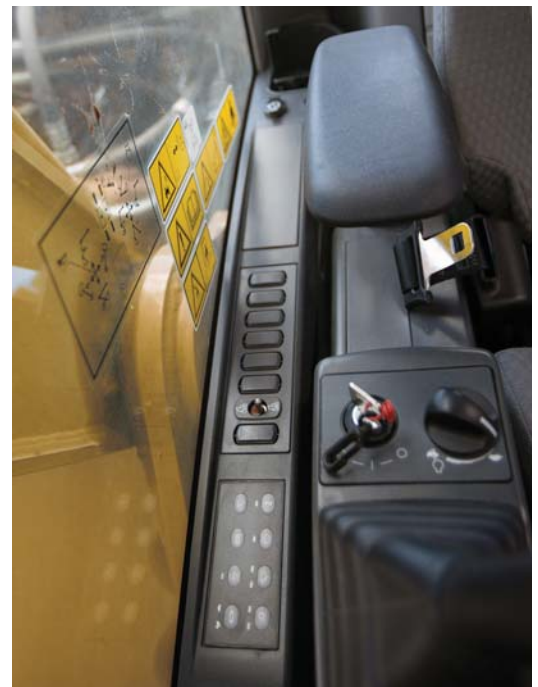

Engine

A powerful engine with excellent reliability and low fuel consumption delivering more while boosting your bottom line.

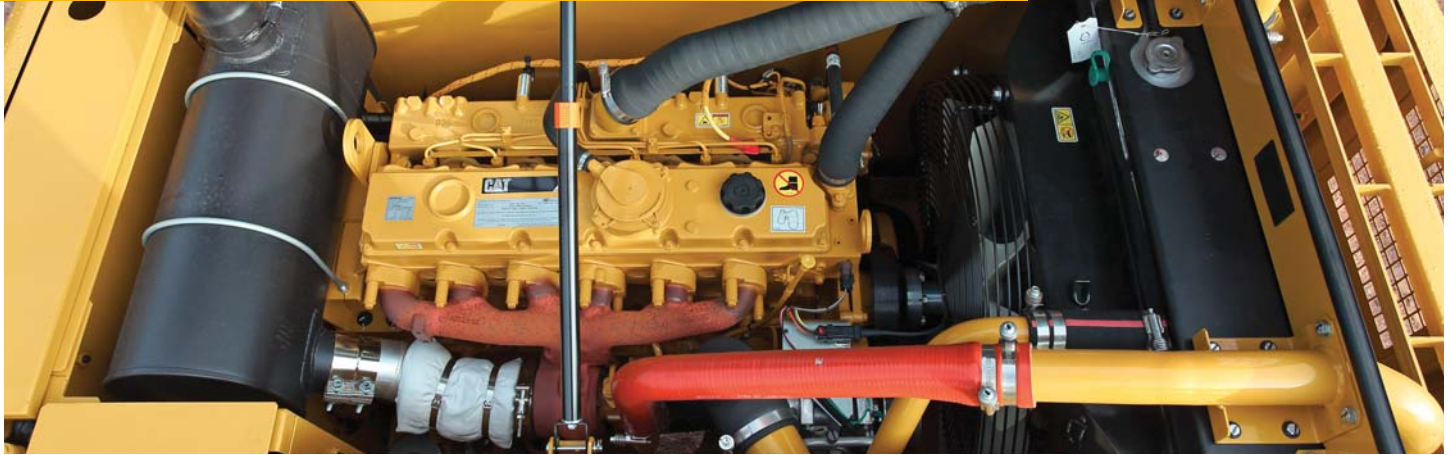

The Cat C7.1 engine has been designed to meet Tier 3, Stage IIIA equivalent emission standards with mechanical governed fuel system. The engine is powerful, strong, and durable to meet all of your application needs. An ECO-mode feature helps reduce fuel consumption by up to 15 percent for fuel-conscious customers. The C7.1 engines incorporate proven, robust components and precision manufacturing you can count on for reliable and efficient operation. This engine is less sensitive to low quality fuel and also delivers better fuel consumption.

Air Cleaner and Air Precleaner

The radial seal air filter features a double-layered filter core for more efficient filtration and is located in a compartment behind the cab. A warning is displayed on the monitor when dust accumulates above a preset level. Air precleaner reduces the amount of dust and debris that enter the air intake system which can help maximize engine performance by extending air filter life.

Filtration System

The C7.1 engine features an improved filtration system to ensure good reliability to fuel injection system components. Intervals have been extended and the number of filters reduced to maximize your profit potential.

Variable Speed Fan

Variable speed fan controlled by ECM reduces fuel consumption and noise.



Electric Priming Pump

Eliminate the need for manual priming of fuel after filter changes. This pump reduces the risk of fuel contamination by preventing unfiltered fuel from being backfilled during filter changes as was possible with a manual hand priming pump.

Automatic Engine Speed Control

Automatic engine speed control is activated during no-load or light-load conditions which reduces engine speed to minimize fuel consumption.

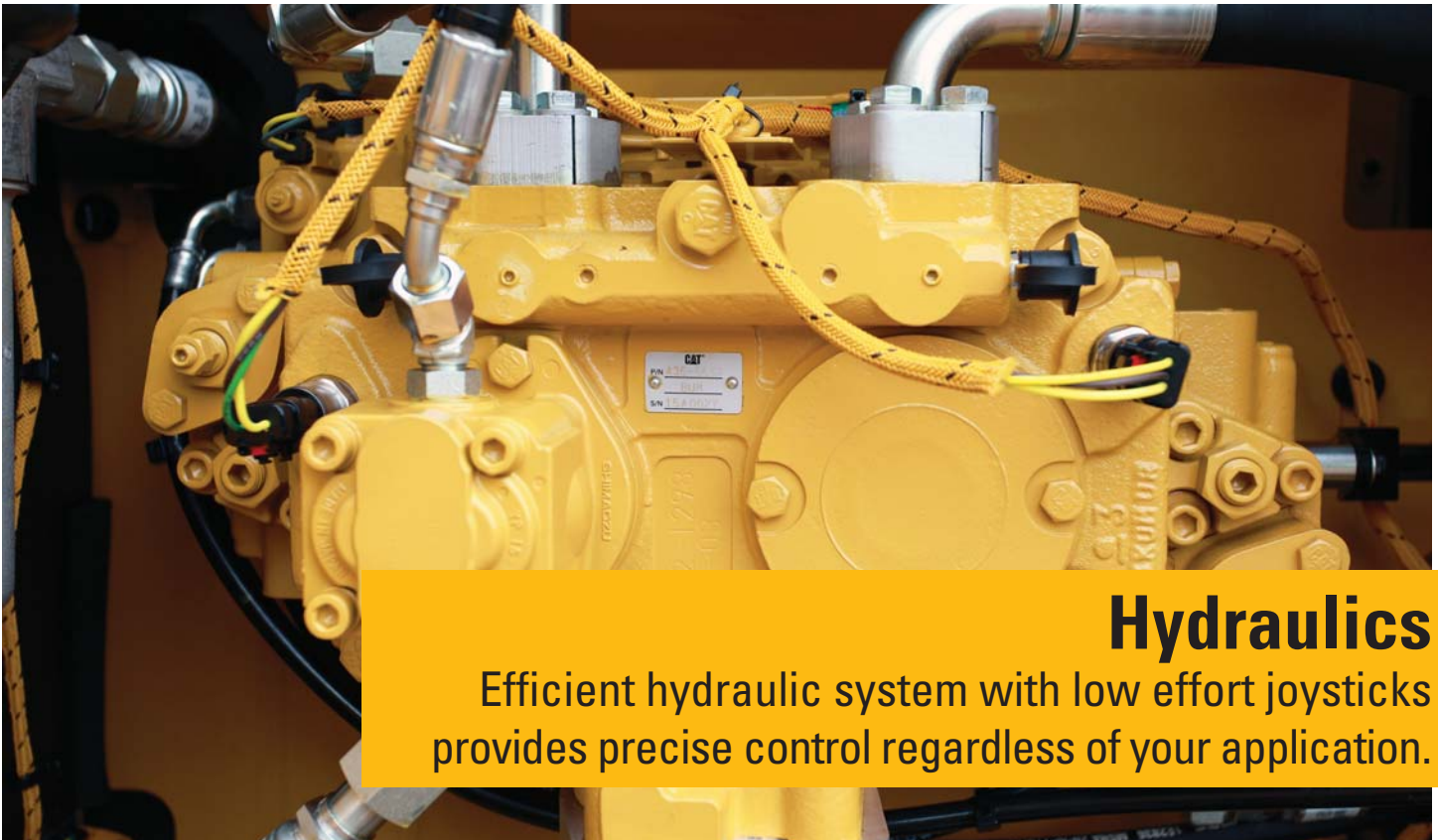

Hydraulics

Efficient hydraulic system with low effort joysticks provides precise control regardless of your application.

Hydraulic System

Hydraulic system pressure is 35 000 kPa (5,076 psi) with 202 L/min (53.36 gal/min) flow from each of the two hydraulic pumps for increased digging performance and productivity.

Pilot System

An independent pilot pump enables smooth precise control for the front linkage, swing, and travel operations.

Component Layout

The 320D2/D2 L hydraulic system and component locations have been designed to provide a high level of system efficiency. The main pumps, control valves, and hydraulic tank are located close together to allow for shorter tubes and lines between components, which reduce friction loss and pressure drops.

Hydraulic Cross-Sensing System

The hydraulic cross-sensing system utilizes each of two hydraulic pumps to 100 percent of engine power under all operating conditions. This improves productivity with faster implement speeds and quicker, stronger pivot turns.

Auxiliary Hydraulic Valve

Control circuits are available as attachments to improve versatility. They allow operation of high- and medium-pressure tools such as shears, grapples, hammers, pulverizers, multi-processors, and vibratory plate compactors.

Boom and Stick Regeneration Circuit

Boom and stick regeneration circuits save energy during boom-down and stick-in operation which increases efficiency, reduces cycle times and pressure loss for higher productivity, lower operating costs, and increased fuel efficiency.

Hydraulic Cylinder Snubbers

Snubbers are located at the rod-end of the boom cylinders and both ends of the stick cylinders to cushion shocks while reducing sound levels and extending component life.

Hydraulic Return Capsule Filter

Capsule filter with a cartridge inside to avoid contamination when accessing the filter and enable changing cleanly without oil spillage. The capable filter with fine mesh size filtering out impurities has a sensor that indicates to the operator if the filter is clogged.

Undercarriage and Structures

Strong and durable, all you expect from Cat excavators.



Carbody Design and Track Roller Frames

The X-shaped, box-section carbody provides excellent resistance to torsional bending. Robot-welded track roller frames are press-formed, pentagonal units to deliver exceptional strength and service life.

Main Frame

The upper frame is designed using inverse “T” shaped beams made out of high-tensile-strength steel providing excellent durability whatever your application. The 320D2/D2 L incorporates a one-piece upper frame table which improves strength and reliability. Both the boom tower and the main frame are constructed of solid plates and the areas adjacent to the boom foot are reinforced, adding to overall durability.

Lower Structure

The 320D2/D2 L carbody features a box section “X” structure which is designed with the carbody welded close to the ends of the track roller frame. As a result, overall rigidity is high and resistance to torsional rigidity between the track roller frames and the carbody is also high. The standard undercarriage is well suited for applications that require frequent repositioning of the machine, restricted work space, or uneven rocky terrain. The standard undercarriage maintains great stability, lift capacity and offers a very stable work platform.

The long (L) undercarriage maximizes stability and lift capacity. This long, wide, and sturdy undercarriage offers a very stable work platform.

Rollers and Idlers

Sealed and lubricated track rollers, carrier rollers, and idlers provide excellent service life to keep your machine in the field and working longer.

Undercarriage

The 320D2/D2 L uses a grease-lubricated type track link with grease being sealed between the pin and the bushing. These seals deliver longer wear life by preventing dirt and debris from entering into the space between the pin and the bushing. The master link incorporates a split type pin which helps make routine service and maintenance quick and easy.

Front Linkage

Reliable, durable, and versatile to meet all your application needs.



Cat front linkages are designed for maximum versatility, productivity, and high efficiency whatever the application.

Heavy Duty Front Linkage

The 5.7 m (18'8") heavy duty (HD) reach boom is reinforced to be used in the severest applications and provide maximum digging capability. They are made of high-tensile-strength steel using a large box-section design with interior baffle plates and an additional bottom guard for long life and durability. The HD reach boom has two stick options available to meet all your application requirements.

The 2.9 m (9'6") heavy duty (HD) stick is the most versatile option and a very good fit for truck loading and trenching applications where you need additional working range.

The 2.5 m (8'2") heavy duty (HD) stick is ideally suited to applications requiring larger bucket sizes. It maximizes digging forces and enables you to get your jobs completed faster.

SLR Boom Front Linkage

Super Long Reach (SLR) machines come with heavy counterweight to give you enhanced stability. Their booms, sticks, and frames are built to handle the stresses such distant work can bring.

- SLR boom (8.85 m/29'0") with SLR stick (6.28 m/20'7")



Cat Connect Technology

Monitor, manage, and enhance job site operations



Cat Connect makes smart use of technology and services to improve your job site efficiency. Using the data from technology-equipped machines, you'll get more information and insight into your equipment and operations than ever before.

Cat Connect technologies offer improvements in these key areas:



EQUIPMENT
MANAGEMENT

Equipment Management – increase uptime and reduce operating costs.



PRODUCTIVITY

Productivity – monitor production and manage job site efficiency.



SAFETY

Safety – enhance job site awareness to keep your people and equipment safe.

Service and Maintenance

Simplified service and maintenance features save you time and money.



Ground-Level Service

The design and layout of the 320D2/D2 L was made with the service technician in mind. Most service locations are easily accessible at ground level to allow service and maintenance to get completed quickly and efficiently.

Air Filter Compartment

The air filters feature a double-element construction for superior cleaning efficiency. When the air filter plugs, a warning is displayed on the cab monitor. Maintenance free batteries are standard along with a battery disconnect switch.

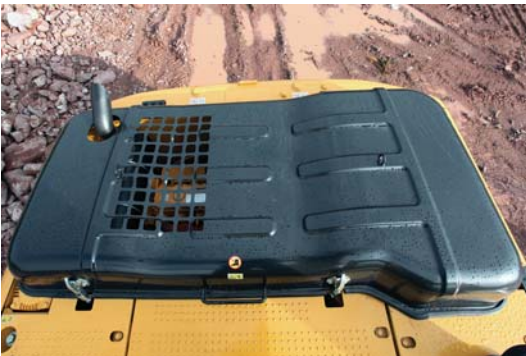

Pump Compartment

A service door on the right side of the upper structure allows ground-level access to the hydraulic pumps, hydraulic filters, engine oil filter, and fuel filters.

Radiator Compartment

The left rear service door allows easy access to the engine radiator, hydraulic oil cooler, air-to-air aftercooler, and AC condenser. A reserve tank and drain cock are attached to the radiator for ground level maintenance.



Greasing Points

A concentrated remote greasing block on the boom allows the greasing of hard-to-reach locations. A remote mounted greasing point on the swing bearing allows ease of service.

Fan Guard

The engine radiator fan is enclosed by a steel guard that provides maximum protection when carrying out routine service and maintenance.

Anti-Skid Plate

Anti-skid plating covers the entire upper structure and storage box to prevent slipping during maintenance. Safety is further enhanced with the addition of countersunk bolts to reduce trip hazards.

Diagnostics and Monitoring

The 320D2/D2 L is equipped with Scheduled Oil Sampling (S-O-SSM) ports for the hydraulic system, engine oil, and coolant. Standard hydraulic test ports enable a service technician to quickly and easily fault find in the event of service issue.

Work Tools

Dig, hammer, rip, and cut with confidence.

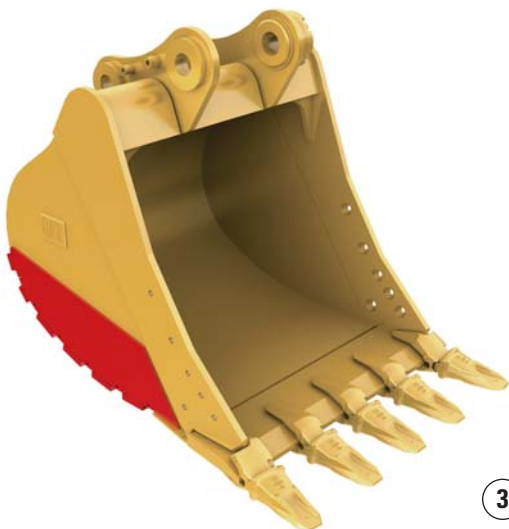

Each Cat work tool is designed to optimize the versatility and performance of your machine. An extensive range of buckets, compactors, grapples, multi-processors, rippers, crushers, pulverizers, hammers, and shears is available for your 320D2/D2 L.

Cat General Duty Buckets (GD)

These buckets are designed for digging in low-impact, moderately abrasive materials such as dirt, loam, gravel, and clay.

Heavy Duty Buckets (HD)

HD buckets are a good starting point when application conditions vary. Especially when conditions include mixed dirt, clay, sand, and gravel.

Severe Duty Buckets (SD)

These buckets are best suited to highly abrasive applications such as shot rock, sand stone, and granite.

Couplers

Quick couplers allow one person to change work tools in seconds for maximum performance and flexibility on a job site. One machine can move rapidly from task to task, and a fleet of similarly equipped machines can share a common work tool inventory.

Cat Pin Grabber Couplers

The Cat Pin Grabber Coupler is easy to activate, easy to engage, easy to disengage. Operating procedures are simple and easy to learn. It's the easiest way to improve productivity on every job site.

One excavator can share buckets and a variety of attachments with similar size excavators. Managing your assets just got easier.

1) *Cat General Duty Buckets (GD)* 2) *Heavy Duty Buckets (HD)*
3) *Severe Duty Buckets (SD)*

B Hammers

B Series hammers have outstanding field-proven reliability and durability for tough applications. It has optimized tool length and design and high grade steel and heat treatment provides high output.

E Series Hammers

E Series hammers bring together customer expectations of performance, quality, and serviceability along with Caterpillar manufacturing and logistics experience.

E Series hammers are quiet, and noise suppression is valuable in urban and restricted work areas.

Pin-on Rippers, Rip and Load Package

Constructed from high-strength steels and built to last, Cat rippers endure in the toughest conditions. The box-section structure is reinforced for maximum rigidity, transmitting the full machine power to the material being ripped. Rippers feature a replaceable wear tip, and most models also come equipped with a replaceable shank protector.

Grapples

Cat grapples replace the bucket on Cat excavators, converting them to the ideal machine for handling loose material, sorting trash, and demolition site cleanup. An array of styles and sizes are available to match excavators to the task at hand.

Multi-Processors

Multi-processors do the work of many types of demolition tools by use of interchangeable jaw sets. Changing jaws allows a single unit to crush, pulverize, and perform a variety of specialized cutting tasks such as cutting steel rebar and tanks.

Shear

Cat shears are designed for Cat machines – taking full advantage of the hydraulic flows and pressures to enhance productivity without compromising safety or causing premature wear of the shear and carrier.

Pulverizer

The excavator mounted mechanical pulverizer is a cost-effective tool for recycling demolished concrete debris. The bucket cylinder on the excavator powers the mechanical pulverizer. This eliminates the need for a dedicated cylinder and associated hydraulics and additional installation cost.

Vibratory Plate Compactor

Compactors enhance the versatility of your excavator and makes compacting faster, more efficient, and cost-effective. Cat compactors are the superior choice for any job site's compaction tasks.

Crusher

The hydraulic concrete crusher has taken modern demolition technology a step further. It is well suited for concrete demolition in residential areas. The hydraulic concrete crusher combines several concrete demolition operations in one piece of equipment:

- breaking out concrete from fixed structures
- pulverizing concrete
- cutting reinforcement rods and small steel profiles



Complete Customer Support

Cat dealer services offer a wide range of personalized solutions.



Product Support

Cat dealers utilize a worldwide computer network to find in-stock parts to minimize machine downtime. You can also save money with our line of remanufactured components.

Machine Selection

Your Cat dealers can provide specific recommendations with detailed comparisons of the Cat machines you are considering before you buy. This ensures you get the right size machine and appropriate work tools to meet all of your application needs.

Maintenance Services

Repair option programs guarantee the cost of repairs up front. Condition monitoring services and diagnostic programs such as scheduled oil sampling, coolant sampling, and technical analysis help you avoid unscheduled repairs.

Customer Support Agreements

Cat dealers offer a variety of product support agreements which can be tailored to meet your specific needs. These plans can cover the entire machine – including attachments – to help protect your investment.

Replacement

Repair, rebuild, or replace? Your Cat dealers can help you evaluate the costs involved so you can make the right choice.

Safety

Make you safer.

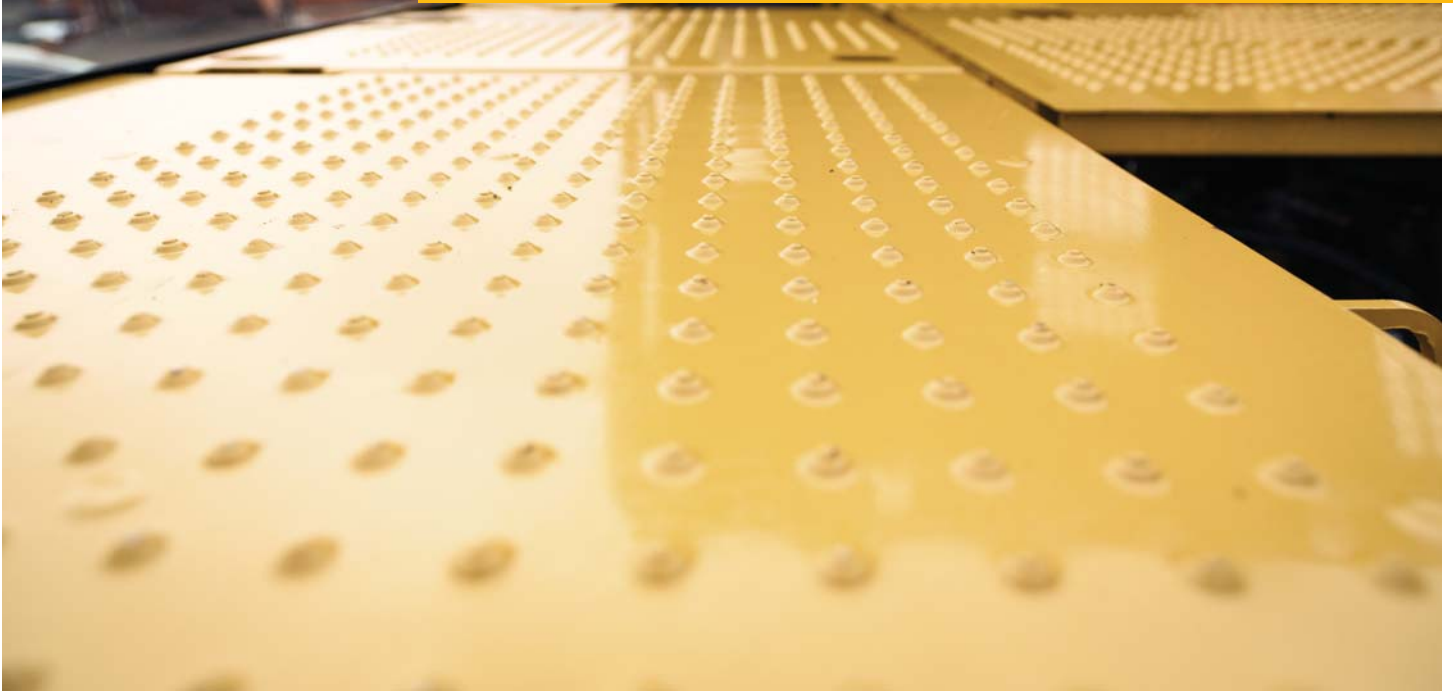

Anti-skid plating with countersunk bolts reduces the potential for slippage and trip hazards, providing a **safe platform** for all routine service and maintenance needs.

The standard **hydraulic lockout lever** isolates all hydraulic and travel functions in the lowered position. It is specifically designed to not allow the operator to leave the cab without first lowering it.

Three circuit breakers protect critical electrical components to increase machine uptime.

A **battery disconnect switch** helps to deter theft by isolating the battery and enhances safety when servicing the machine.

A full length **firewall** separates the engine from the hydraulic pump and offers protection in the event of an incident.

Ground level **shut-off switch** stops all fuel to the engine when activated and shuts down the machine.

320D2/D2 L Hydraulic Excavator Specifications

Engine

Engine Model	Cat C7.1	
Engine Power – ISO 14396	112 kW	150 hp
Net Power – SAE J1349	109 kW	146 hp
Bore	105 mm	4.13 in
Stroke	135 mm	5.31 in
Displacement	7.01 L	428 in ³

- The 320D2/D2 L meets Tier 3, Stage IIIA equivalent emission standards.
- Net power advertised is the power available at the flywheel when the engine is equipped with fan, air cleaner, muffler and alternator.
- The altitude capability (without aid) of 320D2/D2 L is up to 4000 m (13,120 ft) with natural power de-rate above sea level.
- Rating at 1,800 rpm.

Weights

Maximum Operating Weight*	22 300 kg	49,200 lb
Minimum Operating Weight**	21 100 kg	46,500 lb

*Standard Undercarriage – R5.7 (18'8") HD Reach Boom, R2.5B1 (8'2") Reach stick, HD 1.00 m³ (1.3 yd³) bucket and 600 mm (24") TG shoes.

**Long Undercarriage – R5.7 (18'8") HD Reach Boom, R2.9B1 (9'6") HD Reach stick, HD 1.00 m³ (1.3 yd³) bucket and 790 mm (31") TG shoes.

Track

Number of Shoes Each Side – Standard Undercarriage	45 pieces	
Number of Track Rollers Each Side – Standard Undercarriage	7 pieces	
Number of Carrier Rollers Each Side – Standard Undercarriage	2 pieces	
Number of Shoes Each Side – Long Undercarriage	49 pieces	
Number of Track Rollers Each Side – Long Undercarriage	8 pieces	
Number of Carrier Roller Each Side – Long Undercarriage	2 pieces	

Swing Mechanism

Swing Speed	10.9 rpm	
Swing Torque	61.8 kN·m	45,581 lbf·ft

Drive

Maximum Travel Speed – High	5.4 km/h	3.4 mph
Maximum Drawbar Pull	205 kN	46,086 lb

Hydraulic System

Main System – Maximum Flow (Total)	404 L/min	106.7 gal/min
Maximum Pressure – Equipment	35 MPa	5,076 psi
Maximum Pressure – Travel	35 MPa	5,076 psi
Maximum Pressure – Swing	25 MPa	3,626 psi
Pilot System – Maximum Flow (Total)	32.4 L/min	8.6 gal/min
Pilot System – Maximum Pressure	3900 kPa	566 psi
Boom Cylinder – Bore	120 mm	4.7 in
Boom Cylinder – Stroke	1260 mm	49.6 in
Stick Cylinder – Bore	140 mm	5.5 in
Stick Cylinder – Stroke	1504 mm	59.2 in
Bucket Cylinder – Bore	120 mm	4.7 in
Bucket Cylinder – Stroke	1104 mm	43.5 in

Service Refill Capacities

Fuel Tank Capacity	410 L	108.3 gal
Cooling System	25 L	6.6 gal
Engine Oil	22 L	5.8 gal
Swing Drive	8 L	2.1 gal
Final Drive	8 L	2.1 gal
Hydraulic System (including tank)	260 L	68.7 gal
Hydraulic Tank	138 L	36.5 gal

Sound Performance

ISO 6395 (external)	102 dB(A)
ISO 6396 (inside cab)	72 dB(A)

- When properly installed and maintained, the cab offered by Caterpillar, when tested with doors and windows closed according to ANSI/SAE J1166 OCT98, meets OSHA and MSHA requirements for operator sound exposure limits in effect at time of manufacture.
- Hearing protection may be needed when operating with an open operator station and cab (when not properly maintained or doors/windows open) for extended periods or in a noisy environment.

Standards

Brakes	SAE J1026/APR90
Cab/FOGS	SAE J1356 FEB88 ISO 10262

320D2/D2 L Hydraulic Excavator Specifications

Dimensions

All dimensions are approximate.

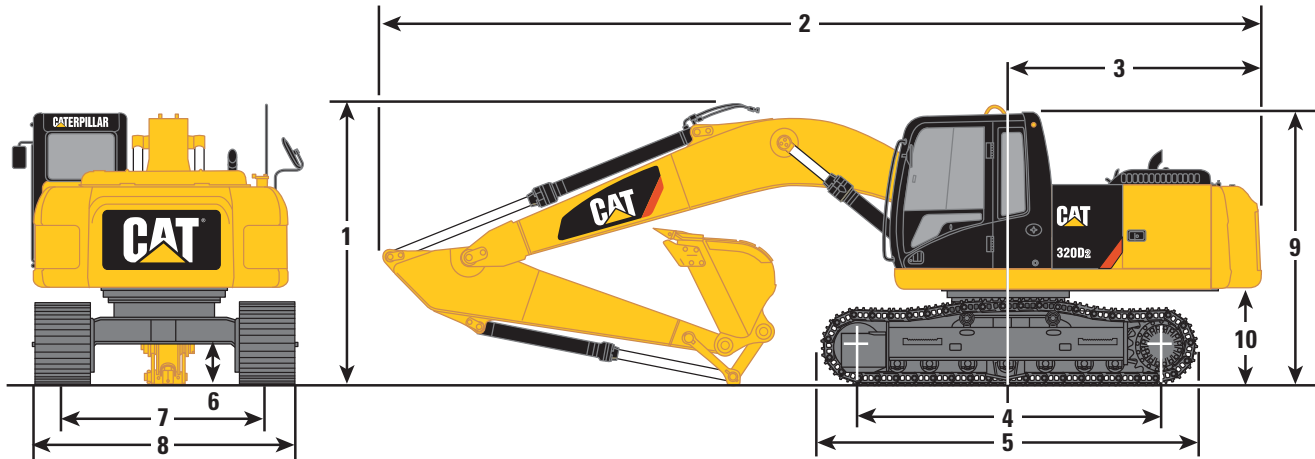

	320D2/D2 L		
Boom Options	HD Reach Boom 5.7 m (18'8")*	HD Reach Boom 5.7 m (18'8")*	Super Long Reach 8.85 m (29'0")**
Stick Options	HD R2.9 B1 (9'6")	HD R2.5 B1 (8'2")	Super Long Reach 6.28 m (20'7")
1 Shipping Height***	3030 mm (9'11")	3050 mm (10'0")	3050 mm (10'0")
2 Shipping Length	9460 mm (31'0")	9460 mm (31'0")	12 680 mm (41'7")
3 Tail Swing Radius	2750 mm (9'0")	2750 mm (9'0")	2750 mm (9'0")
4 Length to Center of Rollers – Standard Undercarriage	3270 mm (10'9")	3270 mm (10'9")	3270 mm (10'9")
Length to Center of Rollers – Long Undercarriage	3650 mm (12'0")	3650 mm (12'0")	3650 mm (12'0")
5 Track Length – Standard Undercarriage	4080 mm (13'5")	4080 mm (13'5")	4080 mm (13'5")
Track Length – Long Undercarriage	4460 mm (14'8")	4460 mm (14'8")	4460 mm (14'8")
6 Ground Clearance****	450 mm (1'6")	450 mm (1'6")	450 mm (1'6")
7 Track Gauge – Standard Undercarriage	2200 mm (7'3")	2200 mm (7'3")	2200 mm (7'3")
Track Gauge – Long Undercarriage	2380 mm (7'10")	2380 mm (7'10")	2380 mm (7'10")
8 Transport Width – Standard Undercarriage			
600 mm (24") Shoe	2800 mm (9'2")	2800 mm (9'2")	2800 mm (9'2")
790 mm (31") Shoe	2990 mm (9'10")	2990 mm (9'10")	2990 mm (9'10")
Transport Width – Long Undercarriage			
600 mm (24") Shoe	2980 mm (9'9")	2980 mm (9'9")	2980 mm (9'9")
700 mm (28") Shoe	3080 mm (10'1")	3080 mm (10'1")	3080 mm (10'1")
790 mm (31") Shoe	3170 mm (10'5")	3170 mm (10'5")	3170 mm (10'5")
9 Cab Height****	2950 mm (9'8")	2950 mm (9'8")	2950 mm (9'8")
10 Counterweight Clearance****	1020 mm (3'4")	1020 mm (3'4")	1020 mm (3'4")

*With GD 1.00 m³ (1.3 yd³) Bucket.

**With GD 0.53 m³ (0.69 yd³) Bucket.

***Including shoe lug height.

****Without shoe lug height.

320D2/D2 L Hydraulic Excavator Specifications

Working Ranges

All dimensions are approximate.

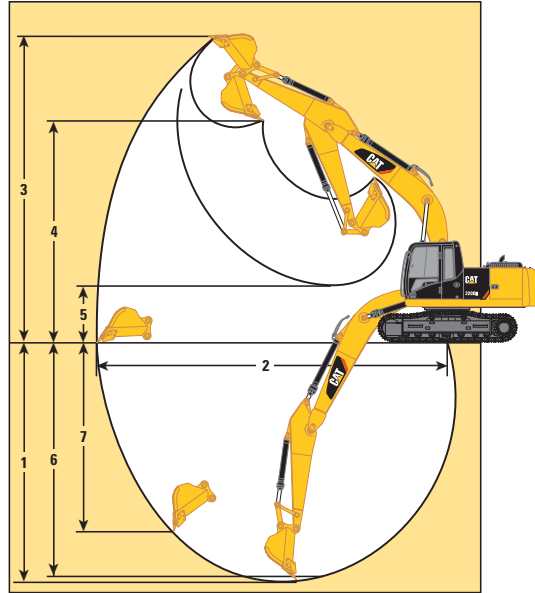

Boom Options	HD Reach Boom 5.7 m (18'8")	HD Reach Boom 5.7 m (18'8")	Super Long Reach 8.85 m (29'0")
Stick Options	HD R2.9 (9'6") B1	HD R2.5 (8'2") B1	Super Long Reach 6.28 m (20'7")
Bucket Tip Radius	1560 mm (5'1")	1560 mm (5'1")	1230 mm (4'0")
1 Maximum Digging Depth	6720 mm (22'1")	6300 mm (20'8")	11 880 mm (39'0")
2 Maximum Reach at Ground Line	9890 mm (32'5")	9470 mm (31'1")	15 730 mm (51'7")
3 Maximum Cutting Height	9490 mm (31'2")	9250 mm (30'4")	13 310 mm (43'8")
4 Maximum Loading Height	6490 mm (21'4")	6290 mm (20'8")	11 010 mm (36'1")
5 Minimum Loading Height	2170 mm (7'1")	2590 mm (8'6")	1970 mm (6'6")
6 Maximum Depth Cut for 2240 mm (8 ft) Level Bottom	6380 mm (20'11")	5960 mm (19'7")	11 780 mm (38'8")
7 Maximum Vertical Wall Digging Depth	5690 mm (18'8")	5290 mm (17'4")	10 560 mm (34'8")
Bucket Digging Force (SAE)	125 kN (28,100 lbf)	125 kN (28,100 lbf)	54 kN (12,100 lbf)
Bucket Digging Force (ISO)	140 kN (31,500 lbf)	140 kN (31,500 lbf)	60 kN (13,500 lbf)
Stick Digging Force (SAE)	104 kN (23,300 lbf)	114 kN (25,700 lbf)	48 kN (10,800 lbf)
Stick Digging Force (ISO)	107 kN (24,000 lbf)	118 kN (26,600 lbf)	49 kN (11,000 lbf)

320D2/D2 L Hydraulic Excavator Specifications

Operating Weight and Ground Pressure

The standard and optional equipment availability vary by region. Please contact your local Cat dealer for more information about the work tools available in your region.

	600 mm (24") Triple Grouser Shoes		790 mm (31") Triple Grouser Shoes	
Standard Undercarriage				
HD Reach Boom – 5.7 m (18'8")				
HD R2.9 (9'6") Stick, HD 1.0 m ³ (1.3 yd ³) Bucket	21 100 kg (46,500 lb)	48.6 kPa (7.0 psi)	21 700 kg (47,800 lb)	37.9 kPa (5.5 psi)
HD R2.5 (8'2") Stick, HD 1.0 m ³ (1.3 yd ³) Bucket	21 100 kg (46,500 lb)	48.6 kPa (7.0 psi)	21 700 kg (47,800 lb)	37.9 kPa (5.5 psi)
SLR Boom – 8.85 m (29'0")				
SLR – 6.28 m (20'7") Stick, GD 0.53 m ³ (0.69 yd ³) Bucket	20 900 kg (46,100 lb)	48.1 kPa (7.0 psi)	21 400 kg (47,200 lb)	37.4 kPa (5.4 psi)
Long Undercarriage				
HD Reach Boom – 5.7 m (18'8")				
HD R2.9 (9'6") Stick, HD 1.0 m ³ (1.3 yd ³) Bucket	21 600 kg (47,600 lb)	44.9 kPa (6.5 psi)	22 300 kg (49,200 lb)	35.2 kPa (5.1 psi)
HD R2.9 (9'6") Stick Rebar, HD 1.0 m ³ (1.3 yd ³) Bucket	21 600 kg (47,600 lb)	44.9 kPa (6.5 psi)	22 300 kg (49,200 lb)	35.2 kPa (5.1 psi)
HD R2.5 (8'2") Stick, HD 1.0 m ³ (1.3 yd ³) Bucket	21 600 kg (47,600 lb)	44.9 kPa (6.5 psi)	22 200 kg (49,000 lb)	35.0 kPa (5.1 psi)
SLR Boom – 8.85 m (29'0")				
SLR – 6.28 m (20'7") Stick, GD 0.53 m ³ (0.69 yd ³) Bucket	21 400 kg (47,200 lb)	44.5 kPa (6.4 psi)	22 000 kg (48,500 lb)	34.7 kPa (5.0 psi)

320D2/D2 L Hydraulic Excavator Specifications

Major Component Weights

Base Machine including boom cylinders, pins, fluids, operator	6640 kg (14,640 lb)
Undercarriage	
Standard Undercarriage	4180 kg (9,220 lb)
Long Undercarriage	4490 kg (9,900 lb)
Counterweight	3700 kg (8,160 lb)
Boom (including lines, pins and stick cylinder)	
HD Reach Boom – 5.7 m (18'8")	2020 kg (4,450 lb)
SLR Boom – 8.85 m (29'0")	2190 kg (4,830 lb)
Stick (including lines, pins, bucket cylinder and bucket linkage)	
HD R2.9 (9'6") B1 Stick	1110 kg (2,450 lb)
HD R2.5 (8'2") B1 Stick	1080 kg (2,380 lb)
SLR – 6.28 m (20'7") Stick	1260 kg (2,780 lb)
Track Shoe (standard/per two track)	
600 mm (24") TG	2480 kg (5,470 lb)
790 mm (31") TG	3060 kg (6,750 lb)
Track Shoe (long/per two track)	
600 mm (24") TG	2700 kg (5,950 lb)
790 mm (31") TG	3330 kg (7,340 lb)
GD 1.0 m ³ (1.3 yd ³) Bucket with Sidecutter and Tip	760 kg (1,680 lb)
HD 1.0 m ³ (1.3 yd ³) Bucket with Sidecutter and Tip	970 kg (2,140 lb)
GD 0.53 m ³ (0.69 yd ³) Bucket with Tip	400 kg (880 lb)

Note: Kg and lb were rounded up separately so some of the kg and lb do not match.

ISO 6016 Operating Weight Criteria: Base Machine with fronts, bucket, full fuel tank (and fluids), 75 kg (165 lb) operator. This standard excludes optional attachments.

320D2/D2 L Hydraulic Excavator Specifications

320D2 Bucket Specifications and Compatibility – Standard Undercarriage

	Linkage	Width		Capacity		Weight		Fill	HD Reach Boom 5.7 m (18'8")				
		mm	in	m ³	yd ³	kg	lb		%	R2.5B1HD	R2.5B1HD	R2.9B1HD	R2.9B1HD
										600 mm (24") Track Shoes	790 mm (31") Track Shoes	600 mm (24") Track Shoes	790 mm (31") Track Shoes
Without Quick Coupler													
Cat General Duty (GD) EAME	B	600	24	0.46	0.61	551	1,213	100%	●	●	●	●	
	B	750	30	0.64	0.84	622	1,370	100%	●	●	●	●	
	B	900	36	0.81	1.06	668	1,473	100%	●	●	●	●	
	B	1200	48	1.19	1.56	803	1,770	100%	⊖	⊖	○	○	
	B	1300	51	1.30	1.71	835	1,840	100%	○	⊖	○	○	
	B	1400	55	1.43	1.87	870	1,918	100%	○	○	◇	◇	
Cat General Duty (GDC)	B	600	24	0.55	0.72	619	1,363	100%	●	●	●	●	
	B	750	30	0.75	0.98	710	1,566	100%	●	●	●	●	
	B	900	36	0.95	1.24	787	1,735	100%	⊙	●	⊖	⊙	
	B	1050	42	1.16	1.52	848	1,870	100%	⊖	⊖	○	○	
	B	1200	48	1.38	1.80	926	2,041	100%	○	○	◇	◇	
	B	1350	54	1.59	2.08	1004	2,213	100%	◇	◇	◇	◇	
Cat General Duty – CCL	B	1150	46	0.90	1.18	719	1,585	100%	●	●	⊙	⊙	
	B	1250	50	1.00	1.31	751	1,656	100%	⊙	⊙	⊖	⊙	
	B	1150	46	0.90	1.18	762	1,680	100%	●	●	⊙	⊙	
	B	1250	50	1.00	1.31	797	1,756	100%	⊙	⊙	⊖	⊖	
	B	1400	56	1.14	1.49	863	1,902	100%	⊖	⊖	○	○	
Heavy Duty (HD)	B	600	24	0.46	0.61	649	1,431	100%	●	●	●	●	
	B	750	30	0.64	0.84	748	1,649	100%	●	●	●	●	
	B	900	36	0.81	1.06	826	1,821	100%	●	●	⊙	●	
	B	1050	42	1.00	1.31	880	1,940	100%	⊙	⊙	⊖	⊖	
	B	1200	48	1.19	1.56	907	1,999	100%	⊖	⊖	○	○	
	B	1200	48	1.19	1.56	918	2,024	100%	⊖	⊖	○	○	
	B	1200	48	1.19	1.56	972	2,141	100%	○	⊖	○	○	
	B	1300	52	1.30	1.71	962	2,120	100%	○	○	◇	○	
	B	1350	54	1.38	1.81	1054	2,322	100%	◇	○	◇	◇	
	B	1350	54	1.40	1.83	1012	2,230	100%	○	○	◇	◇	
Heavy Duty – China	B	1050	43	1.00	1.31	879	1,937	100%	⊙	⊙	⊖	⊖	
	B	1200	49	1.19	1.56	942	2,076	100%	○	⊖	○	○	
	B	1350	54	1.38	1.81	1003	2,210	100%	○	○	◇	◇	
Severe Duty (SD)	B	600	24	0.46	0.61	694	1,530	90%	●	●	●	●	
	B	750	30	0.64	0.84	802	1,768	90%	●	●	●	●	
	B	900	36	0.81	1.06	889	1,959	90%	●	●	●	●	
	B	1050	42	1.00	1.31	964	2,125	90%	⊙	⊙	⊖	⊖	
	B	1200	48	1.19	1.56	1053	2,320	90%	⊖	⊖	○	○	
	B	1200	48	1.19	1.56	1001	2,207	90%	⊖	⊖	○	○	
Severe Duty – China	B	1100	43	1.00	1.31	969	2,136	90%	⊙	⊙	⊖	⊖	
	B	1250	49	1.19	1.56	1068	2,355	90%	⊖	⊖	○	○	
Maximum load pin-on (payload + bucket)								kg	2625	2710	2405	2485	
								lb	5,786	5,973	5,301	5,477	

The above loads are in compliance with hydraulic excavator standard EN474, they do not exceed 87% of hydraulic lifting capacity or 75% of tipping capacity with front linkage fully extended at ground line with bucket curled.

Capacity based on ISO 7451.

Bucket weight with Cat General Duty tips.

Maximum Material Density:

- 2100 kg/m³ (3,500 lb/yd³)
- ⊙ 1800 kg/m³ (3,000 lb/yd³)
- ⊖ 1500 kg/m³ (2,500 lb/yd³)
- 1200 kg/m³ (2,000 lb/yd³)
- ◇ 900 kg/m³ (1,500 lb/yd³)

Caterpillar recommends using appropriate work tools to maximize the value customers receive from our products. Use of work tools, including buckets, which are outside of Caterpillar's recommendations or specifications for weight, dimensions, flows, pressures, etc. may result in less-than-optimal performance, including but not limited to reductions in production, stability, reliability, and component durability. Improper use of a work tool resulting in sweeping, prying, twisting and/or catching of heavy loads will reduce the life of the boom and stick.

320D2/D2 L Hydraulic Excavator Specifications

320D2 Bucket Specifications and Compatibility – Standard Undercarriage

	Linkage	Width		Capacity		Weight		Fill	HD Reach Boom 5.7 m (18'8")				
		mm	in	m ³	yd ³	kg	lb		%	R2.5B1HD	R2.5B1HD	R2.9B1HD	R2.9B1HD
										600 mm (24") Track Shoes	790 mm (31") Track Shoes	600 mm (24") Track Shoes	790 mm (31") Track Shoes
With Pin Grabber Coupler													
Cat General Duty (GD) EAME	B	600	24	0.46	0.61	551	1,213	100%	●	●	●	●	
	B	750	30	0.64	0.84	622	1,370	100%	●	●	●	●	
	B	900	36	0.81	1.06	668	1,473	100%	⊙	●	⊖	⊙	
	B	1200	48	1.19	1.56	803	1,770	100%	○	○	◇	◇	
	B	1300	51	1.30	1.71	835	1,840	100%	◇	◇	◇	◇	
	B	1400	55	1.43	1.87	870	1,918	100%	◇	◇	◇	◇	
Cat General Duty (GDC)	B	600	24	0.55	0.72	619	1,363	100%	●	●	●	●	
	B	750	30	0.75	0.98	710	1,566	100%	●	●	⊙	⊙	
	B	900	36	0.95	1.24	787	1,735	100%	⊖	⊖	○	○	
	B	1050	42	1.16	1.52	848	1,870	100%	○	○	◇	◇	
	B	1200	48	1.38	1.80	926	2,041	100%	◇	◇	X	X	
	B	1350	54	1.59	2.08	1004	2,213	100%	X	X	X	X	
Heavy Duty (HD)	B	600	24	0.46	0.61	649	1,431	100%	●	●	●	●	
	B	750	30	0.64	0.84	748	1,649	100%	●	●	⊙	●	
	B	900	36	0.81	1.06	826	1,821	100%	⊖	⊙	⊖	⊖	
	B	1050	42	1.00	1.31	880	1,940	100%	○	○	◇	○	
	B	1200	48	1.19	1.56	907	1,999	100%	◇	○	◇	◇	
	B	1200	48	1.19	1.56	918	2,024	100%	◇	○	◇	◇	
	B	1200	48	1.19	1.56	972	2,141	100%	◇	◇	◇	◇	
	B	1300	52	1.30	1.71	962	2,120	100%	◇	◇	X	X	
	B	1350	54	1.38	1.81	1054	2,322	100%	X	◇	X	X	
	B	1350	54	1.40	1.83	1012	2,230	100%	◇	◇	X	X	
Severe Duty (SD)	B	600	24	0.46	0.61	694	1,530	90%	●	●	●	●	
	B	750	30	0.64	0.84	802	1,768	90%	●	●	●	●	
	B	900	36	0.81	1.06	889	1,959	90%	⊙	⊙	⊖	⊖	
	B	1050	42	1.00	1.31	964	2,125	90%	○	⊖	○	○	
	B	1200	48	1.19	1.56	1053	2,320	90%	◇	○	◇	◇	
	B	1200	48	1.19	1.56	1001	2,207	90%	◇	○	◇	◇	
Maximum load with coupler (payload + bucket)								kg	2215	2300	1995	2075	
								lb	4,883	5,070	4,398	4,574	

The above loads are in compliance with hydraulic excavator standard EN474, they do not exceed 87% of hydraulic lifting capacity or 75% of tipping capacity with front linkage fully extended at ground line with bucket curled.

Capacity based on ISO 7451.

Bucket weight with Cat General Duty tips.

Maximum Material Density:

- 2100 kg/m³ (3,500 lb/yd³)
- ⊙ 1800 kg/m³ (3,000 lb/yd³)
- ⊖ 1500 kg/m³ (2,500 lb/yd³)
- 1200 kg/m³ (2,000 lb/yd³)
- ◇ 900 kg/m³ (1,500 lb/yd³)
- X Not Recommended

Caterpillar recommends using appropriate work tools to maximize the value customers receive from our products. Use of work tools, including buckets, which are outside of Caterpillar's recommendations or specifications for weight, dimensions, flows, pressures, etc. may result in less-than-optimal performance, including but not limited to reductions in production, stability, reliability, and component durability. Improper use of a work tool resulting in sweeping, prying, twisting and/or catching of heavy loads will reduce the life of the boom and stick.

320D2/D2 L Hydraulic Excavator Specifications

320D2 L Bucket Specifications and Compatibility – Long Undercarriage

	Linkage	Width		Capacity		Weight		Fill	HD Reach Boom 5.7 m (18'8")				
		mm	in	m ³	yd ³	kg	lb		%	R2.5B1HD	R2.5B1HD	R2.9B1HD	R2.9B1HD
										600 mm (24") Track Shoes	790 mm (31") Track Shoes	600 mm (24") Track Shoes	790 mm (31") Track Shoes
Without Quick Coupler													
Cat General Duty (GD) EAME	B	600	24	0.46	0.61	551	1,213	100%	●	●	●	●	
	B	750	30	0.64	0.84	622	1,370	100%	●	●	●	●	
	B	900	36	0.81	1.06	668	1,473	100%	●	●	●	●	
	B	1200	48	1.19	1.56	803	1,770	100%	⊙	⊙	⊖	⊙	
	B	1300	51	1.30	1.71	835	1,840	100%	⊖	⊙	⊖	⊖	
	B	1400	55	1.43	1.87	870	1,918	100%	⊖	⊖	○	○	
Cat General Duty (GDC)	B	600	24	0.55	0.72	619	1,363	100%	●	●	●	●	
	B	750	30	0.75	0.98	710	1,566	100%	●	●	●	●	
	B	900	36	0.95	1.24	787	1,735	100%	●	●	●	●	
	B	1050	42	1.16	1.52	848	1,870	100%	⊙	⊙	⊖	⊙	
	B	1200	48	1.38	1.80	926	2,041	100%	⊖	⊖	○	○	
	B	1350	54	1.59	2.08	1004	2,213	100%	○	○	◇	○	
Cat General Duty – CCL	B	1150	46	0.90	1.18	719	1,585	100%	●	●	●	●	
	B	1250	50	1.00	1.31	751	1,656	100%	●	●	●	●	
	B	1150	46	0.90	1.18	762	1,680	100%	●	●	●	●	
	B	1250	50	1.00	1.31	797	1,756	100%	●	●	⊙	●	
	B	1400	56	1.14	1.49	863	1,902	100%	⊙	⊙	⊖	⊙	
Heavy Duty (HD)	B	600	24	0.46	0.61	649	1,431	100%	●	●	●	●	
	B	750	30	0.64	0.84	748	1,649	100%	●	●	●	●	
	B	900	36	0.81	1.06	826	1,821	100%	●	●	●	●	
	B	1050	42	1.00	1.31	880	1,940	100%	●	●	⊙	⊙	
	B	1200	48	1.19	1.56	907	1,999	100%	⊙	⊙	⊖	⊖	
	B	1200	48	1.19	1.56	918	2,024	100%	⊙	⊙	⊖	⊖	
	B	1200	48	1.19	1.56	972	2,141	100%	⊖	⊙	⊖	⊖	
	B	1300	52	1.30	1.71	962	2,120	100%	⊖	⊖	○	⊖	
	B	1350	54	1.38	1.81	1054	2,322	100%	○	⊖	○	○	
	B	1350	54	1.40	1.83	1012	2,230	100%	○	⊖	○	○	
Heavy Duty – China	B	1050	43	1.00	1.31	879	1,937	100%	●	●	⊙	⊙	
	B	1200	49	1.19	1.56	942	2,076	100%	⊙	⊙	⊖	⊖	
	B	1350	54	1.38	1.81	1003	2,210	100%	⊖	⊖	○	○	
Severe Duty (SD)	B	600	24	0.46	0.61	694	1,530	90%	●	●	●	●	
	B	750	30	0.64	0.84	802	1,768	90%	●	●	●	●	
	B	900	36	0.81	1.06	889	1,959	90%	●	●	●	●	
	B	1050	42	1.00	1.31	964	2,125	90%	●	●	⊙	●	
	B	1200	48	1.19	1.56	1053	2,320	90%	⊙	⊙	⊖	⊖	
	B	1200	48	1.19	1.56	1001	2,207	90%	⊙	⊙	⊖	⊙	
Severe Duty – China	B	1100	43	1.00	1.31	969	2,136	90%	●	●	⊙	●	
	B	1250	49	1.19	1.56	1068	2,355	90%	⊙	⊙	⊖	⊖	
Maximum load pin-on (payload + bucket)								kg	2990	3090	2755	2850	
								lb	6,590	6,810	6,072	6,281	

The above loads are in compliance with hydraulic excavator standard EN474, they do not exceed 87% of hydraulic lifting capacity or 75% of tipping capacity with front linkage fully extended at ground line with bucket curled.

Capacity based on ISO 7451.

Bucket weight with Cat General Duty tips.

Maximum Material Density:

- 2100 kg/m³ (3,500 lb/yd³)
- ⊙ 1800 kg/m³ (3,000 lb/yd³)
- ⊖ 1500 kg/m³ (2,500 lb/yd³)
- 1200 kg/m³ (2,000 lb/yd³)
- ◇ 900 kg/m³ (1,500 lb/yd³)

Caterpillar recommends using appropriate work tools to maximize the value customers receive from our products. Use of work tools, including buckets, which are outside of Caterpillar's recommendations or specifications for weight, dimensions, flows, pressures, etc. may result in less-than-optimal performance, including but not limited to reductions in production, stability, reliability, and component durability. Improper use of a work tool resulting in sweeping, prying, twisting and/or catching of heavy loads will reduce the life of the boom and stick.

320D2/D2 L Hydraulic Excavator Specifications

320D2 L Bucket Specifications and Compatibility – Long Undercarriage

	Linkage	Width		Capacity		Weight		Fill	HD Reach Boom 5.7 m (18'8")				
		mm	in	m ³	yd ³	kg	lb		%	R2.5B1HD	R2.5B1HD	R2.9B1HD	R2.9B1HD
										600 mm (24") Track Shoes	790 mm (31") Track Shoes	600 mm (24") Track Shoes	790 mm (31") Track Shoes
With Pin Grabber Coupler													
Cat General Duty (GD) EAME	B	600	24	0.46	0.61	551	1,213	100%	●	●	●	●	
	B	750	30	0.64	0.84	622	1,370	100%	●	●	●	●	
	B	900	36	0.81	1.06	668	1,473	100%	●	●	●	●	
	B	1200	48	1.19	1.56	803	1,770	100%	⊖	⊖	○	○	
	B	1300	51	1.30	1.71	835	1,840	100%	○	○	○	○	
	B	1400	55	1.43	1.87	870	1,918	100%	○	○	◇	◇	
Cat General Duty (GDC)	B	600	24	0.55	0.72	619	1,363	100%	●	●	●	●	
	B	750	30	0.75	0.98	710	1,566	100%	●	●	●	●	
	B	900	36	0.95	1.24	787	1,735	100%	⊙	⊙	⊖	⊙	
	B	1050	42	1.16	1.52	848	1,870	100%	⊖	⊖	○	○	
	B	1200	48	1.38	1.80	926	2,041	100%	○	○	◇	◇	
	B	1350	54	1.59	2.08	1004	2,213	100%	◇	◇	X	◇	
Heavy Duty (HD)	B	600	24	0.46	0.61	649	1,431	100%	●	●	●	●	
	B	750	30	0.64	0.84	748	1,649	100%	●	●	●	●	
	B	900	36	0.81	1.06	826	1,821	100%	●	●	⊙	⊙	
	B	1050	42	1.00	1.31	880	1,940	100%	⊖	⊙	⊖	⊖	
	B	1200	48	1.19	1.56	907	1,999	100%	○	⊖	○	○	
	B	1200	48	1.19	1.56	918	2,024	100%	○	⊖	○	○	
	B	1200	48	1.19	1.56	972	2,141	100%	○	⊖	○	○	
	B	1300	52	1.30	1.71	962	2,120	100%	○	○	◇	◇	
	B	1350	54	1.38	1.81	1054	2,322	100%	◇	○	◇	◇	
	B	1350	54	1.40	1.83	1012	2,230	100%	◇	○	◇	◇	
Severe Duty (SD)	B	600	24	0.46	0.61	694	1,530	90%	●	●	●	●	
	B	750	30	0.64	0.84	802	1,768	90%	●	●	●	●	
	B	900	36	0.81	1.06	889	1,959	90%	●	●	⊙	●	
	B	1050	42	1.00	1.31	964	2,125	90%	⊙	⊙	⊖	⊖	
	B	1200	48	1.19	1.56	1053	2,320	90%	○	⊖	○	○	
	B	1200	48	1.19	1.56	1001	2,207	90%	⊖	⊖	○	○	
Maximum load with coupler (payload + bucket)								kg	2580	2680	2345	2440	
								lb	5,687	5,907	5,169	5,378	

The above loads are in compliance with hydraulic excavator standard EN474, they do not exceed 87% of hydraulic lifting capacity or 75% of tipping capacity with front linkage fully extended at ground line with bucket curled.

Capacity based on ISO 7451.

Bucket weight with Cat General Duty tips.

Maximum Material Density:

- 2100 kg/m³ (3,500 lb/yd³)
- ⊙ 1800 kg/m³ (3,000 lb/yd³)
- ⊖ 1500 kg/m³ (2,500 lb/yd³)
- 1200 kg/m³ (2,000 lb/yd³)
- ◇ 900 kg/m³ (1,500 lb/yd³)
- X Not Recommended

Caterpillar recommends using appropriate work tools to maximize the value customers receive from our products. Use of work tools, including buckets, which are outside of Caterpillar's recommendations or specifications for weight, dimensions, flows, pressures, etc. may result in less-than-optimal performance, including but not limited to reductions in production, stability, reliability, and component durability. Improper use of a work tool resulting in sweeping, prying, twisting and/or catching of heavy loads will reduce the life of the boom and stick.

320D2/D2 L Hydraulic Excavator Specifications

320D2/D2 L Work Tool Offering Guide*

Boom Type	HD Reach			
	2.5 HD	2.9 HD	2.5 HD	2.9 HD
Stick Size	Standard		Long	
Undercarriage				
Hydraulic Hammer	H115E s H120E s H130E s^^ B20	H115E s H120E s H130E s^ B20^^	H115E s H120E s H130E s B20	H115E s H120E s H130E s B20
Multi-Processor	MP318 CC Jaw^ MP318 D Jaw^ MP318 P Jaw*** MP318 S Jaw^ MP318 U Jaw***	MP318 CC Jaw*** # MP318 D Jaw*** MP318 P Jaw*** # MP318 S Jaw*** MP318 U Jaw*** #	MP318 CC Jaw^^ MP318 D Jaw MP318 P Jaw^^ MP318 S Jaw MP318 U Jaw^^	MP318 CC Jaw** MP318 D Jaw** MP318 P Jaw^ MP318 S Jaw^^ MP318 U Jaw^
Pulverizer	P215^^	P215^	P215	P215
Crusher	P315^	P315***	P315^^	P315**
Demolition and Sorting Grapple	G315B-D/R^ G315B-D/R fixed CAN	G315B-D/R*** # G315B-D/R fixed CAN	G315B-D/R^^ G315B-D/R fixed CAN	G315B-D/R** G315B-D/R fixed CAN
Scrap and Demolition Shear	S320B*** S325B##	S320B*** # S325B##	S320B^^ S325B##	S320B*** S325B##
Compactor (Vibratory Plate)	CVP110	CVP110	CVP110	CVP110
Contractors' Grapple		G120B – G130B	G120B – G130B	G120B – G130B
Orange Peel Grapple				
Clamshell Grapple				
Rippers				
Pin Grabber Coupler	Cat-PG			
Dedicated Quick Coupler	CW-40			
	CW-40s			

These work tools are available for the 320D2/D2 L.
Consult your Cat dealer for proper match.

* Offerings not available in all areas. Matches are dependent on excavator configurations. Consult your Cat dealer to determine what is offered in your area and for proper work tool match.

** Pin-on or CW

*** Pin-on only

Work over the front only

Boom mount

^ Work over the front only with CW (Pin-on and CW)









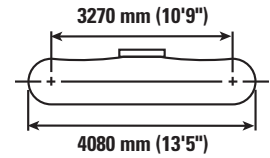
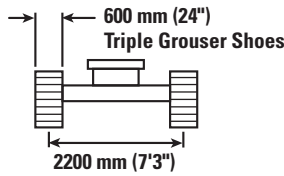
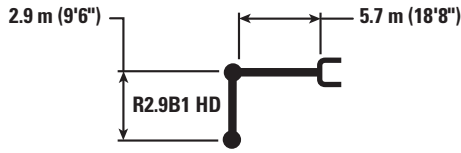



^^ Work over the front only with Cat-PG (Pin-on, CW and Cat-PG)

Note: Demolition and Sorting Grapple: D-Demolition shells, R-Recycling shells
fixed CAN – fixed hinge plates for CW quick coupler usage.

320D2/D2 L Hydraulic Excavator Specifications

320D2 Heavy Duty Reach Boom Lift Capacities – Standard Undercarriage



		1.5 m/5.0 ft		3.0 m/10.0 ft		4.5 m/15.0 ft		6.0 m/20.0 ft		7.5 m/25.0 ft				
													m ft	
7.5 m 25.0 ft	kg lb							*4500	*4500			*3850 *8,600	*3850 *8,600	6.15 20.00
6.0 m 20.0 ft	kg lb							*4800 *10,550	4600 9,900			*3600 *7,900	3300 7,300	7.29 24.20
4.5 m 15.0 ft	kg lb							*5300 *11,500	4450 9,550	4600 9,800	3100 6,600	*3500 *7,700	2750 6,100	7.99 26.70
3.0 m 10.0 ft	kg lb					*7750 *16,650	6400 13,800	*6050 *13,150	4200 9,000	4450 9,600	2950 6,350	*3600 *7,900	2500 5,450	8.36 27.50
1.5 m 5.0 ft	kg lb					*9350 20,100	5850 12,600	6050 12,950	3900 8,450	4350 9,300	2850 6,100	3600 7,950	2350 5,200	8.45 28.30
0.0 m 0.0 ft	kg lb			*6200 *14,200	*6200 *14,200	9000 19,350	5550 11,900	5800 12,500	3750 8,050	4200 9,100	2750 5,900	3700 8,100	2400 5,250	8.26 27.50
-1.5 m -5.0 ft	kg lb	*6600 *14,750	*6600 *14,750	*10 700 *24,300	10 300 22,100	8900 19,100	5450 11,700	5750 12,300	3650 7,850	4200 9,000	2700 5,850	4000 8,800	2600 5,700	7.78 25.80
-3.0 m -10.0 ft	kg lb	*11 350 *25,500	*11 350 *25,500	*13 700 *29,600	10 500 22,550	8950 19,250	5500 11,850	5750 12,400	3700 7,950			4700 10,450	3050 6,800	6.95 23.30
-4.5 m -15.0 ft	kg lb			*10 850 *23,250	*10 850 *23,250	*7800 *16,600	5750 12,350					*5900 *12,900	4250 9,600	5.60 18.30



ISO 10567



*Indicates that the load is limited by hydraulic lifting capacity rather than tipping load. The above loads are in compliance with hydraulic excavator lift capacity standard ISO 10567:2007. They do not exceed 87% of hydraulic lifting capacity or 75% of tipping load. Weight of all lifting accessories must be deducted from the above lifting capacities. Lifting capacities are based on the machine standing on a firm, uniform supporting surface. The use of a work tool attachment point to handle/lift objects, could affect the machine lift performance.









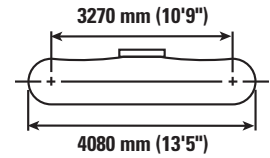
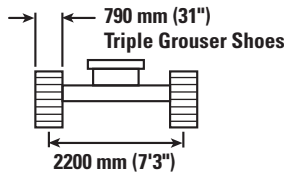
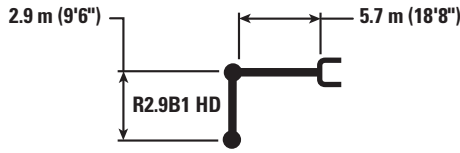



Lift capacity stays with ±5% for all available track shoes.

Always refer to the appropriate Operation and Maintenance Manual for specific product information.

320D2/D2 L Hydraulic Excavator Specifications

320D2 Heavy Duty Reach Boom Lift Capacities – Standard Undercarriage



		1.5 m/5.0 ft		3.0 m/10.0 ft		4.5 m/15.0 ft		6.0 m/20.0 ft		7.5 m/25.0 ft				
														m ft
7.5 m 25.0 ft	kg lb							*4500	*4500			*3850 *8,600	*3850 *8,600	6.15 20.00
6.0 m 20.0 ft	kg lb							*4800 *10,550	4700 10,100			*3600 *7,900	3350 7,500	7.29 24.20
4.5 m 15.0 ft	kg lb							*5300 *11,500	4550 9,800	4700 10,100	3150 6,750	*3500 *7,700	2850 6,250	7.99 26.70
3.0 m 10.0 ft	kg lb					*7750 *16,650	6550 14,100	*6050 *13,150	4300 9,250	4600 9,850	3050 6,550	*3600 *7,900	2550 5,600	8.36 27.50
1.5 m 5.0 ft	kg lb					*9350 *20,150	6000 12,950	6200 13,300	4050 8,650	4450 9,550	2950 6,300	3750 8,200	2450 5,350	8.45 28.30
0.0 m 0.0 ft	kg lb			*6200 *14,200	*6200 *14,200	9250 19,850	5700 12,250	6000 12,900	3850 8,250	4350 9,350	2850 6,050	3800 8,350	2500 5,450	8.26 27.50
-1.5 m -5.0 ft	kg lb	*6600 *14,750	*6600 *14,750	*10 700 *24,300	10 600 22,700	9150 19,650	5600 12,050	5900 12,700	3750 8,100	4300 9,300	2800 6,000	4100 9,050	2650 5,850	7.78 25.80
-3.0 m -10.0 ft	kg lb	*11 350 *25,500	*11 350 *25,500	*13 700 *29,600	10 800 23,150	9200 19,800	5650 12,200	5950 12,750	3800 8,150			4850 10,750	3150 7,000	6.95 23.30
-4.5 m -15.0 ft	kg lb			*10 850 *23,250	*10 850 *23,250	*7800 *16,600	5900 12,700					*5900 *12,900	4400 9,850	5.60 18.30



ISO 10567



*Indicates that the load is limited by hydraulic lifting capacity rather than tipping load. The above loads are in compliance with hydraulic excavator lift capacity standard ISO 10567:2007. They do not exceed 87% of hydraulic lifting capacity or 75% of tipping load. Weight of all lifting accessories must be deducted from the above lifting capacities. Lifting capacities are based on the machine standing on a firm, uniform supporting surface. The use of a work tool attachment point to handle/lift objects, could affect the machine lift performance.

Lift capacity stays with ±5% for all available track shoes.

Always refer to the appropriate Operation and Maintenance Manual for specific product information.

320D2/D2 L Hydraulic Excavator Specifications

320D2 Heavy Duty Reach Boom Lift Capacities – Long Undercarriage

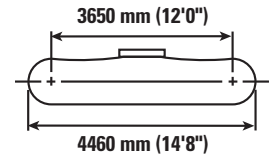
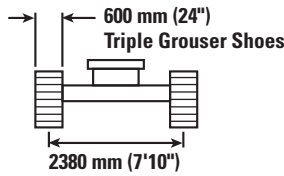
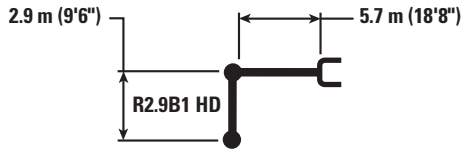

		1.5 m/5.0 ft		3.0 m/10.0 ft		4.5 m/15.0 ft		6.0 m/20.0 ft		7.5 m/25.0 ft		m ft		
7.5 m 25.0 ft	kg lb							*4500	*4500			*3850 *8,600	*3850 *8,600	6.15 20.00
6.0 m 20.0 ft	kg lb							*4800 *10,550	*4800 *10,550			*3600 *7,900	*3600 *7,900	7.29 24.20
4.5 m 15.0 ft	kg lb							*5300 *11,500	4900 10,600	*4950 *10,850	3400 7,300	*3500 *7,700	3050 6,750	7.99 26.70
3.0 m 10.0 ft	kg lb					*7750 *16,650	7150 15,400	*6050 *13,150	4650 10,000	5250 11,300	3300 7,100	*3600 *7,900	2800 6,100	8.36 27.50
1.5 m 5.0 ft	kg lb					*9350 *20,150	6600 14,200	*6900 *14,900	4400 9,450	5100 11,000	3200 6,850	*3800 *8,350	2650 5,850	8.45 28.30
0.0 m 0.0 ft	kg lb			*6200 *14,200	*6200 *14,200	*10 250 *22,150	6 250 13,500	6950 14,950	4200 9,050	5000 10,750	3100 6,650	*4200 *9,300	2700 5,950	8.26 27.50
-1.5 m -5.0 ft	kg lb	*6600 *14,750	*6600 *14,750	*10 700 *24,300	*10 700 *24,300	*10 350 *22,350	6200 13,300	6850 14,750	4100 8,850	5000 10,700	3050 6,550	4750 10,450	2900 6,400	7.78 25.80
-3.0 m -10.0 ft	kg lb	*11 350 *25,500	*11 350 *25,500	*13 700 *29,600	12 150 26,000	*9650 *20,850	6250 13,400	6900 14,850	4150 8,950			5600 12,450	3450 7,600	6.95 23.30
-4.5 m -15.0 ft	kg lb			*10 850 *23,250	*10 850 *23,250	*7800 *16,600	6450 13,950					*5900 *12,900	4800 10,750	5.60 18.30



ISO 10567



*Indicates that the load is limited by hydraulic lifting capacity rather than tipping load. The above loads are in compliance with hydraulic excavator lift capacity standard ISO 10567:2007. They do not exceed 87% of hydraulic lifting capacity or 75% of tipping load. Weight of all lifting accessories must be deducted from the above lifting capacities. Lifting capacities are based on the machine standing on a firm, uniform supporting surface. The use of a work tool attachment point to handle/lift objects, could affect the machine lift performance.

Lift capacity stays with ±5% for all available track shoes.

Always refer to the appropriate Operation and Maintenance Manual for specific product information.

320D2/D2 L Hydraulic Excavator Specifications

320D2 Heavy Duty Reach Boom Lift Capacities – Long Undercarriage

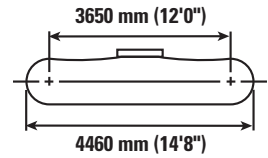
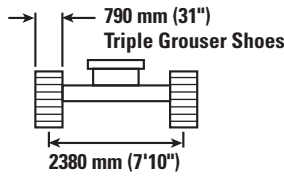
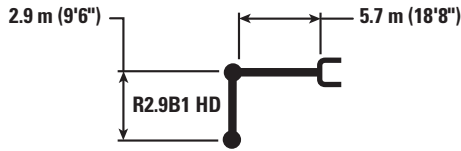

		1.5 m/5.0 ft		3.0 m/10.0 ft		4.5 m/15.0 ft		6.0 m/20.0 ft		7.5 m/25.0 ft		m ft		
7.5 m 25.0 ft	kg lb							*4500	*4500			*3850 *8,600	*3850 *8,600	6.15 20.00
6.0 m 20.0 ft	kg lb							*4800 *10,550	*4800 *10,550			*3600 *7,900	*3600 *7,900	7.29 24.20
4.5 m 15.0 ft	kg lb							*5300 *11,500	5050 10,850	*4950 *10,850	3500 7,550	*3500 *7,700	3150 6,950	7.99 26.70
3.0 m 10.0 ft	kg lb					*7750 *16,650	7350 15,800	*6050 *13,150	4800 10,300	*5300 *11,500	3400 7,300	*3600 *7,900	2850 6,300	8.36 27.50
1.5 m 5.0 ft	kg lb					*9350 *20,150	6800 14,600	*6900 *14,900	4500 9,750	5250 11,350	3300 7,050	*3800 *8,350	2750 6,050	8.45 28.30
0.0 m 0.0 ft	kg lb			*6200 *14,200	*6200 *14,200	*10 250 *22,150	6450 13,900	7200 15,400	4350 9,300	5150 11,100	3200 6,850	*4200 *9,300	2800 6,100	8.26 27.50
-1.5 m -5.0 ft	kg lb	*6600 *14,750	*6600 *14,750	*10 700 *24,300	*10 700 *24,300	*10 350 *22,350	6350 13,700	7100 15,200	4250 9,150	5150 11,050	3150 6,800	4900 10,750	3000 6,600	7.78 25.80
-3.0 m -10.0 ft	kg lb	*11 350 *25,500	*11 350 *25,500	*13 700 *29,600	12 500 26,750	*9650 *20,850	6450 13,800	7100 15,300	4300 9,200			5800 12,800	3550 7,850	6.95 23.30
-4.5 m -15.0 ft	kg lb			*10 850 *23,250	*10 850 *23,250	*7800 *16,600	6650 14,350					*5900 *12,900	4900 11,100	5.60 18.30



ISO 10567



*Indicates that the load is limited by hydraulic lifting capacity rather than tipping load. The above loads are in compliance with hydraulic excavator lift capacity standard ISO 10567:2007. They do not exceed 87% of hydraulic lifting capacity or 75% of tipping load. Weight of all lifting accessories must be deducted from the above lifting capacities. Lifting capacities are based on the machine standing on a firm, uniform supporting surface. The use of a work tool attachment point to handle/lift objects, could affect the machine lift performance.

Lift capacity stays with ±5% for all available track shoes.

Always refer to the appropriate Operation and Maintenance Manual for specific product information.

320D2/D2 L Hydraulic Excavator Specifications

320D2 Super Long Reach Boom Lift Capacities – Long Undercarriage

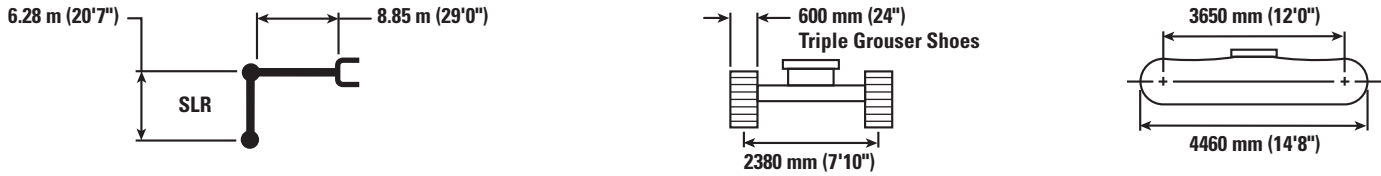

		1.5 m/5.0 ft		3.0 m/10.0 ft		4.5 m/15.0 ft		6.0 m/20.0 ft		7.5 m/25.0 ft				m ft
12.0 m 40.0 ft	kg lb											*1300 *2,850	*1300 *2,850	10.35 33.31
10.5 m 35.0 ft	kg lb											*1200 *2,600	*1200 *2,600	11.66 37.83
9.0 m 30.0 ft	kg lb											*1150 *2,500	*1150 *2,500	12.66 41.25
7.5 m 25.0 ft	kg lb											*1100 *2,450	*1100 *2,450	13.41 43.83
6.0 m 20.0 ft	kg lb											*1100 *2,400	*1100 *2,400	13.96 45.71
4.5 m 15.0 ft	kg lb											*1150 *2,450	*1150 *2,450	14.34 46.99
3.0 m 10.0 ft	kg lb			*4700 *11,900	*4700 *11,900	*5800 *12,400	*5800 *12,400	*4300 *9,200	*4300 *9,200	*3500 *7,550	*3500 *7,550	*1150 *2,500	1150 2,500	14.54 47.71
1.5 m 5.0 ft	kg lb					*6750 *15,750	6400 13,850	*5150 *11,050	4450 9,550	*4000 *8,650	3300 7,050	*1200 *2,650	1100 2,400	14.60 47.89
0.0 m 0.0 ft	kg lb			*2050 *4,550	*2050 *4,550	*4700 *10,750	*4700 *10,750	*5800 *12,550	4000 8,600	*4450 *9,650	3000 6,450	*1300 *2,800	1100 2,400	14.49 47.54
-1.5 m -5.0 ft	kg lb	*2100 *4,600	*2100 *4,600	*2750 *6,100	*2750 *6,100	*4650 *10,550	*4650 *10,550	*6250 *13,500	3700 8,000	4800 10,300	2800 6,000	*1400 *3,000	1100 2,400	14.22 46.65
-3.0 m -10.0 ft	kg lb	*2850 *6,350	*2850 *6,350	*3550 *7,900	*3550 *7,900	*5200 *11,750	*5200 *11,500	6400 13,750	3600 7,700	4650 10,000	2650 5,750	*1500 *3,350	1150 2,500	13.79 45.19
-4.5 m -15.0 ft	kg lb	*3700 *8,200	*3700 *8,200	*4450 *9,900	*4450 *9,900	*6100 *13,750	5400 11,600	6350 13,650	3550 7,650	4600 9,900	2600 5,600	*1700 *3,800	1250 2,700	13.17 43.10
-6.0 m -20.0 ft	kg lb	*4550 *10,150	*4550 *10,150	*5450 *12,200	*5450 *12,200	*7250 *16,350	5500 11,800	*6300 *13,550	3600 7,700	4600 9,900	2650 5,650	*2000 *4,500	1350 3,050	12.34 40.27
-7.5 m -25.0 ft	kg lb	*5500 *12,300	*5500 *12,300	*6600 *14,850	*6600 *14,850	*7600 *16,350	5700 12,250	*5850 *12,600	3700 7,950	4700 10,100	2700 5,800	*2550 *5,700	1600 3,600	11.24 36.55
-9.0 m -30.0 ft	kg lb			*8000 *18,050	*8000 *18,050	*6550 *14,000	5950 12,850	*5150 *10,950	3900 8,400	*4150 *8,750	2850 6,150	*2900 *6,350	2050 4,600	9.79 31.60
-10.5 m -35.0 ft	kg lb							*3900 *3900	*3900 *3900	*3000 *3000	*3000 *3000	*2800 *2800	*2800 *2800	7.80



ISO 10567



*Indicates that the load is limited by hydraulic lifting capacity rather than tipping load. The above loads are in compliance with hydraulic excavator lift capacity standard ISO 10567:2007. They do not exceed 87% of hydraulic lifting capacity or 75% of tipping load. Weight of all lifting accessories must be deducted from the above lifting capacities. Lifting capacities are based on the machine standing on a firm, uniform supporting surface. The use of a work tool attachment point to handle/lift objects, could affect the machine lift performance.









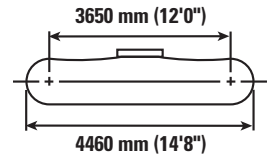
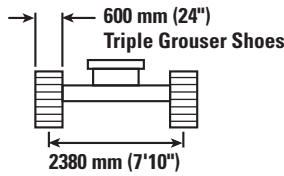
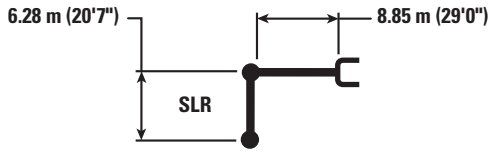

Lift capacity stays with ±5% for all available track shoes.

Always refer to the appropriate Operation and Maintenance Manual for specific product information.

320D2/D2 L Hydraulic Excavator Specifications

320D2 Super Long Reach Boom Lift Capacities – Long Undercarriage



		9.0 m/30.0 ft		10.5 m/35.0 ft		12.0 m/40.0 ft		13.5 m/45.0 ft				
												m ft
12.0 m 40.0 ft	kg lb									*1300 *2,850	*1300 *2,850	10.35 33.31
10.5 m 35.0 ft	kg lb			*4,700	*4,700					*1200 *2,600	*1200 *2,600	11.66 37.83
9.0 m 30.0 ft	kg lb					*2000 *3,700	1950 *3,700			*1150 *2,500	*1150 *2,500	12.66 41.25
7.5 m 25.0 ft	kg lb			*2150 *4,750	*2150 *4,750	*2150 *4,700	1900 4,050			*1100 *2,450	*1100 *2,450	13.41 43.83
6.0 m 20.0 ft	kg lb			*2300 *5,000	*2300 *5,000	*2250 *4,850	1850 3,950	*1850 *3,250	1450 3,050	*1100 *2,400	*1100 *2,400	13.96 45.71
4.5 m 15.0 ft	kg lb	*2700 *5,850	*2700 *5,850	*2500 *5,400	2300 4,850	*2350 *5,100	1800 3,800	*2250 *4,650	1400 2,950	*1150 *2,450	*1150 *2,450	14.34 46.99
3.0 m 10.0 ft	kg lb	*3000 *6,550	2750 5,900	*2700 *5,850	2150 4,550	*2500 *5,400	1700 3,600	2250 4,800	1350 2,850	*1150 *2,500	1150 2,500	14.54 47.71
1.5 m 5.0 ft	kg lb	*3350 *7,250	2550 5,400	*2950 *6,350	2000 4,250	2650 5,650	1600 3,400	2200 4,700	1300 2,750	*1200 *2,650	1100 2,400	14.60 47.89
0.0 m 0.0 ft	kg lb	*3650 *7,950	2350 5,000	3100 6,700	1850 4,000	2550 5,500	1500 3,250	2150 4,550	1250 2,650	*1300 *2,800	1100 2,400	14.49 47.54
-1.5 m -5.0 ft	kg lb	3700 8,000	2200 4,700	3000 6,450	1750 3,750	2500 5,350	1450 3,100	2100 4,500	1200 2,550	*1400 *3,000	1100 2,400	14.22 46.65
-3.0 m -10.0 ft	kg lb	3600 7,750	2100 4,500	2950 6,300	1700 3,650	2450 5,250	1400 3,000	2050 *3,700	1200 2,500	*1500 *3,350	1150 2,500	13.79 45.19
-4.5 m -15.0 ft	kg lb	3550 7,650	2050 4,400	2900 6,200	1650 3,550	2400 5,200	1400 2,950			*1700 *3,800	1250 2,700	13.17 43.10
-6.0 m -20.0 ft	kg lb	3600 7,700	2050 4,400	2900 6,250	1650 3,600	2450 *5,150	1400 3,050			*2000 *4,500	1350 3,050	12.34 40.27
-7.5 m -25.0 ft	kg lb	3650 7,850	2100 4,550	3000 6,400	1750 3,750					*2550 *5,700	1600 3,600	11.24 36.55
-9.0 m -30.0 ft	kg lb	*3300 *6,950	2250 4,850							*2900 *6,350	2050 4,600	9.79 31.60
-10.5 m -35.0 ft	kg lb									*2800 *2800	*2800	7.80



ISO 10567



*Indicates that the load is limited by hydraulic lifting capacity rather than tipping load. The above loads are in compliance with hydraulic excavator lift capacity standard ISO 10567:2007. They do not exceed 87% of hydraulic lifting capacity or 75% of tipping load. Weight of all lifting accessories must be deducted from the above lifting capacities. Lifting capacities are based on the machine standing on a firm, uniform supporting surface. The use of a work tool attachment point to handle/lift objects, could affect the machine lift performance.









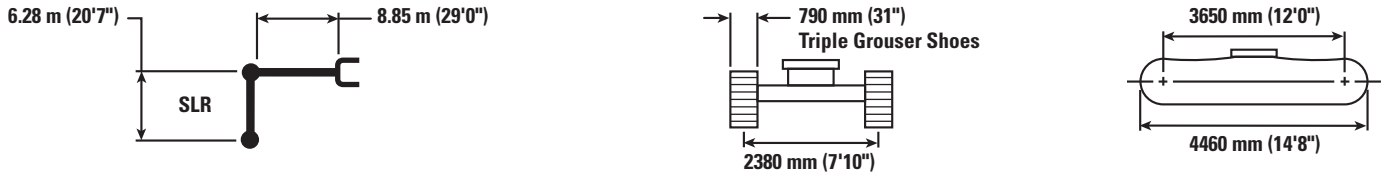



Lift capacity stays with ±5% for all available track shoes.

Always refer to the appropriate Operation and Maintenance Manual for specific product information.

320D2/D2 L Hydraulic Excavator Specifications

320D2 Super Long Reach Boom Lift Capacities – Long Undercarriage



		1.5 m/5.0 ft		3.0 m/10.0 ft		4.5 m/15.0 ft		6.0 m/20.0 ft		7.5 m/25.0 ft				m ft
														
12.0 m 40.0 ft	kg lb											*1300 *2,850	*1300 *2,850	10.35 33.31
10.5 m 35.0 ft	kg lb											*1200 *2,600	*1200 *2,600	11.66 37.83
9.0 m 30.0 ft	kg lb											*1150 *2,500	*1150 *2,500	12.66 41.25
7.5 m 25.0 ft	kg lb											*1100 *2,450	*1100 *2,450	13.41 43.83
6.0 m 20.0 ft	kg lb											*1100 *2,400	*1100 *2,400	13.96 45.71
4.5 m 15.0 ft	kg lb											*1150 *2,450	*1150 *2,450	14.34 46.99
3.0 m 10.0 ft	kg lb			*4700 *11,900	*4700 *11,900	*5800 *12,400	*5800 *12,400	*4300 *9,200	*4300 *9,200	*3500 *7,550	*3500 *7,550	*1150 *2,500	*1150 *2,500	14.54 47.71
1.5 m 5.0 ft	kg lb					*6750 *15,750	6600 14,250	*5150 *11,050	4550 9,800	*4000 *8,650	3400 7,250	*1200 *2,650	1150 2,500	14.60 47.89
0.0 m 0.0 ft	kg lb			*2050 *4,550	*2050 *4,550	*4700 *10,750	*4700 *10,750	*5800 *12,550	4100 8,850	*4450 *9,650	3100 6,650	*1300 *2,800	1150 2,500	14.49 47.54
-1.5 m -5.0 ft	kg lb	*2100 *4,600	*2100 *4,600	*2750 *6,100	*2750 *6,100	*4650 *10,550	*4650 *10,550	*6250 *13,500	3850 8,250	*4800 *10,400	2900 6,200	*1400 *3,000	1150 2,500	14.22 46.65
-3.0 m -10.0 ft	kg lb	*2850 *6,350	*2850 *6,350	*3550 *7,900	*3550 *7,900	*5200 *11,750	*5200 *11,750	*6450 *13,950	3700 8,000	4800 10,350	2750 5,950	*1500 *3,350	1200 2,600	13.79 45.19
-4.5 m -15.0 ft	kg lb	*3700 *8,200	*3700 *8,200	*4450 *9,900	*4450 *9,900	*6100 *13,750	5600 12,000	*6450 *14,000	3700 7,900	4750 10,200	2700 5,850	*1700 *3,800	1300 2,800	13.17 43.10
-6.0 m -20.0 ft	kg lb	*4550 *10,150	*4550 *10,150	*5450 *12,200	*5450 *12,200	*7250 *16,350	5700 12,250	*6300 *13,550	3700 8,000	4750 10,250	2750 5,850	*2000 *4,500	1450 3,150	12.34 40.27
-7.5 m -25.0 ft	kg lb	*5500 *12,300	*5500 *12,300	*6600 *14,850	*6600 *14,850	*7600 *16,350	5900 12,650	*5850 *12,600	3850 8,250	*4700 *10,100	2800 6,050	*2550 *5,700	1650 3,700	11.24 36.55
-9.0 m -30.0 ft	kg lb			*8000 *18,050	*8000 *18,050	*6550 *14,000	6150 13,250	*5150 *10,950	4000 8,650	*4150 *8,750	2950 6,350	*2900 *6,350	2100 4,750	9.79 31.60
-10.5 m -35.0 ft	kg lb							*3900 *3900	*3900 *3900	*3000 *3000	*3000 *3000	*2800 *2800	*2800 *2800	7.80



ISO 10567



*Indicates that the load is limited by hydraulic lifting capacity rather than tipping load. The above loads are in compliance with hydraulic excavator lift capacity standard ISO 10567:2007. They do not exceed 87% of hydraulic lifting capacity or 75% of tipping load. Weight of all lifting accessories must be deducted from the above lifting capacities. Lifting capacities are based on the machine standing on a firm, uniform supporting surface. The use of a work tool attachment point to handle/lift objects, could affect the machine lift performance.









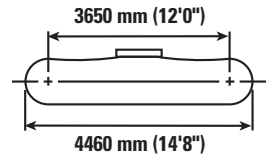
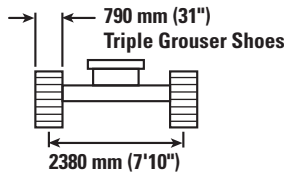
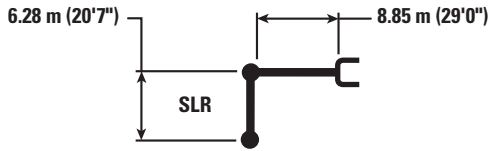

Lift capacity stays with ±5% for all available track shoes.

Always refer to the appropriate Operation and Maintenance Manual for specific product information.

320D2/D2 L Hydraulic Excavator Specifications

320D2 Super Long Reach Boom Lift Capacities – Long Undercarriage



		9.0 m/30.0 ft		10.5 m/35.0 ft		12.0 m/40.0 ft		13.5 m/45.0 ft				
												m ft
12.0 m 40.0 ft	kg lb									*1300 *2,850	*1300 *2,850	10.35 33.31
10.5 m 35.0 ft	kg lb			*4,700	*4,700					*1200 *2,600	*1200 *2,600	11.66 37.83
9.0 m 30.0 ft	kg lb					*2000 *3,700	2000 *3,700			*1150 *2,500	*1150 *2,500	12.66 41.25
7.5 m 25.0 ft	kg lb			*2150 *4,750	*2150 *4,750	*2150 *4,700	1950 4,200			*1100 *2,450	*1100 *2,450	13.41 43.83
6.0 m 20.0 ft	kg lb			*2300 *5,000	*2300 *5,000	*2250 *4,850	1900 4,100	*1850 *3,250	1500 3,150	*1100 *2,400	*1100 *2,400	13.96 45.71
4.5 m 15.0 ft	kg lb	*2700 *5,850	*2700 *5,850	*2500 *5,400	2350 5,000	*2350 *5,100	1850 3,900	*2250 *4,650	1450 3,050	*1150 *2,450	*1150 *2,450	14.34 46.99
3.0 m 10.0 ft	kg lb	*3000 *6,550	2800 6,050	*2700 *5,850	2200 4,700	*2500 *5,400	1750 3,750	2350 4,950	1400 2,950	*1150 *2,500	*1150 *2,500	14.54 47.71
1.5 m 5.0 ft	kg lb	*3350 *7,250	2600 5,600	*2950 *6,350	2050 4,400	*2650 *5,750	1650 3,550	2250 4,850	1350 2,850	*1200 *2,650	1150 2,500	14.60 47.89
0.0 m 0.0 ft	kg lb	*3650 *7,950	2400 5,200	*3150 *6,850	1950 4,150	2650 5,650	1550 3,350	2200 4,750	1300 2,750	*1300 *2,800	1150 2,500	14.49 47.54
-1.5 m -5.0 ft	kg lb	3850 8,250	2250 4,850	3100 6,650	1850 3,900	2550 5,500	1500 3,200	2150 4,650	1250 2,650	*1400 *3,000	1150 2,500	14.22 46.65
-3.0 m -10.0 ft	kg lb	3750 8,050	2200 4,650	3050 6,500	1750 3,750	2500 5,400	1450 3,100	2150 *3,700	1250 2,650	*1500 *3,350	1200 2,600	13.79 45.19
-4.5 m -15.0 ft	kg lb	3700 7,950	2150 4,550	3000 6,450	1750 3,700	2500 5,400	1450 3,100			*1700 *3,800	1300 2,800	13.17 43.10
-6.0 m -20.0 ft	kg lb	3700 7,950	2150 4,600	3000 6,450	1750 3,750	2550 *5,150	1450 3,150			*2000 *4,500	1450 3,150	12.34 40.27
-7.5 m -25.0 ft	kg lb	3750 8,100	2200 4,700	3100 6,650	1800 3,900					*2550 *5,700	1650 3,700	11.24 36.55
-9.0 m -30.0 ft	kg lb	*3300 *6,950	2300 5,050							*2900 *6,350	2100 4,750	9.79 31.60
-10.5 m -35.0 ft	kg lb									*2800 *2800	*2800	7.80



ISO 10567



*Indicates that the load is limited by hydraulic lifting capacity rather than tipping load. The above loads are in compliance with hydraulic excavator lift capacity standard ISO 10567:2007. They do not exceed 87% of hydraulic lifting capacity or 75% of tipping load. Weight of all lifting accessories must be deducted from the above lifting capacities. Lifting capacities are based on the machine standing on a firm, uniform supporting surface. The use of a work tool attachment point to handle/lift objects, could affect the machine lift performance.

Lift capacity stays with ±5% for all available track shoes.

Always refer to the appropriate Operation and Maintenance Manual for specific product information.

320D2/D2 L Standard Equipment

Standard Equipment

Standard equipment may vary. Consult your Cat dealer for details.

ENGINE

- C7.1 Mechanical engine
- Meets Tier 3, Stage IIIA equivalent emission standards
- 4000 m (13,120 ft) altitude capability
- Radial seal air filters (primary and secondary filter)
- Glow plugs (for cold weather start)
- Automatic engine speed control with one touch low idle
- High ambient cooling package 52° C (125° F)
- Water separator with water level indicator sensor
- Waved fin radiator with space for cleaning
- Two speed travel
- Electric priming pump
- Fuel pressure differential gauge
- Power modes (Eco and Standard)

HYDRAULIC SYSTEM

- Regeneration circuits for boom and stick
- Auxiliary hydraulic valve
- Reverse swing damping valve
- Automatic swing parking brake
- Boom drift reducing valve
- Boom lowering device for back-up
- Stick drift reducing valve
- Straight travel hydraulic circuit
- High performance hydraulic return filters

CAB

- Pressurized cab
- Fully adjustable mechanical suspension seat
- Adjustable armrest
- Seat belt, retractable (51 mm [2 in] width)
- 70/30 split front windshield
- Laminated upper front windshield and tempered other windows
- Sliding upper door window
- Openable front windshield with assist device
- Pillar mounted upper windshield wiper and washer
- Bi-level air conditioner (automatic) with defroster (pressurized function)
- Color LCD display with warning, filter/fluid change, and working hour information
- Control lever joysticks
- Hydraulic activation control lever (lock out for all controls)
- Travel control pedals with removable hand levers
- Radio mounting (DIN size)
- Radio ready
- 12V – 2× maximum 10A power supply
- Two stereo speakers
- Beverage holder
- Coat hook
- Openable roof hatch
- Washable floor mat
- Rolldown sunscreen

UNDERCARRIAGE

- Idler and center section track guiding guard
- Towing eye on base frame
- Grease lubricated track

ELECTRICAL

- Batteries (2 × 750 CCA)

LIGHTS

- Left boom working light
- Right working light mounted in the storage box
- Interior lighting
- Cab mounted working lights

SAFETY & SECURITY

- Cat one key security system
- Door and compartment locks
- Signaling/warning horn
- Rearview mirrors
- Fire wall between engine and pump compartment
- Emergency engine shutoff switch
- Rear window, emergency exit
- Battery disconnect switch

COUNTERWEIGHT

- 3.7 mt (8,160 lb) counterweight

TECHNOLOGY

- Product Link™
- Cat data link receptacle

Optional Equipment

Optional equipment may vary. Consult your Cat dealer for details.

ENGINE

- Starting kit, cold weather, <-32° C (-26° F)
- Air prefilter

CAB

- Control pattern quick changer
- 12V power supply

HYDRAULIC SYSTEM

- Hammer circuit, foot pedal operated
- Quick coupler circuit for Cat pin grabber
- Boom and stick high pressure lines
- Boom and stick quick coupler pressure lines

UNDERCARRIAGE AND GUARD

- 600 mm (24") triple grouser shoes
- 790 mm (31") triple grouser shoes
- Full length track guiding guard
- Guard package includes (HD) bottom, (HD) travel motor, swivel guard
- HD track roller
- Standard undercarriage and long undercarriage

FRONT LINKAGE

- HD R5.7 m (18'8") reach boom
 - HD R2.9B1 (9'6") reach stick
 - HD R2.5B1 (8'2") reach stick
- Super Long Reach (SLR)
 - SLR boom 8.85 m (29'0")
 - SLR stick 6.28 m (20'7")
- Bucket linkage

SECURITY

- Travel alarm
- Rearview camera
- Cab mirror

For more complete information on Cat products, dealer services, and industry solutions, visit us on the web at www.cat.com

AEHQ7775 (02-2016)
(SE Asia and Indonesia)

© 2016 Caterpillar
All rights reserved

Materials and specifications are subject to change without notice. Featured machines in photos may include additional equipment. See your Cat dealer for available options.

CAT, CATERPILLAR, SAFETY.CAT.COM, their respective logos, "Caterpillar Yellow" and the "Power Edge" trade dress, as well as corporate and product identity used herein, are trademarks of Caterpillar and may not be used without permission.

